

PRODUCT INFORMATION PACKET



Model No: 3642
Catalog No: 3642
1/8 HP Fan & Blower Motor, 1075 RPM, 3 Speed, 208-230 Volts, 48 Frame, OAO
Direct Drive Motors



Regal and Genteq are trademarks of Regal Beloit Corporation or one of its affiliated companies.
©2019 Regal Beloit Corporation, All Rights Reserved. MC017097E





Nameplate Specifications

Output HP	1/8 Hp	Frequency	60 Hz
Voltage	208-230 V	Current	0.80 A
Speed	1075 rpm	Service Factor	1
Phase	1	Duty	Continuous Air Over
Insulation Class	B	Frame	48
Enclosure	Open Air Over	Thermal Protection	Thermally Protected
Ambient Temperature	40 °C	UL	Recognized
CSA	Y	CE	N

Technical Specifications

Electrical Type	Permanent Split Capacitor	Poles	6
Rotation	Counterclockwise	Mounting	Resilient Ring
Motor Orientation	Any	Drive End Bearing	Sleeve
Opp Drive End Bearing	Sleeve	Frame Material	Rolled Steel
Shaft Type	Flat	Overall Length	20.00 in
Frame Length	2.82 in	Shaft Diameter	0.500 in
Shaft Extension	7.00 in		

This is an uncontrolled document once printed or downloaded and is subject to change without notice. Date Created:25/10/2019

SIZE A
DWG NO

1.40
MAX

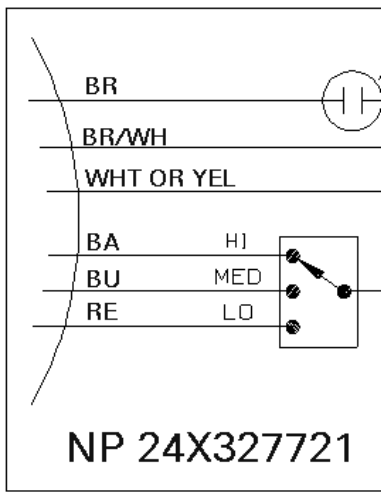

NOTE: THIS DRAWING WILL BE ELECTRIC MOTOR NAMEPLATE SYSTEM.

UNLESS OTHERWISE SPECIFIED	SIGNATURES	DATE
DIMENSIONS ARE IN INCHES	DRAWN CASCHUTT	12/14/94
TOLERANCES ON:	CHECKED	
2 PL DECIMALS ±	ENGRG	
3 PL DECIMALS ±	ISSUED	
ANGLES ±		
FRACTIONS ±		
MATERIAL:	CAD NO	
APPLIED PRACTICES:		

F39: XNP8