

PRODUCT INFORMATION PACKET



Model No: 3739HS
Catalog No: 3739HS
3/4 HP Condenser Fan Motor, 1075 RPM, 460 Volts, 48 Frame, TEAO
Condenser Fans Motors



Regal and Genteq are trademarks of Regal Beloit Corporation or one of its affiliated companies.
©2019 Regal Beloit Corporation, All Rights Reserved. MC017097E





Nameplate Specifications

Output HP	3/4 Hp	Frequency	60 Hz
Voltage	460 V	Current	2.03 A
Speed	1075 rpm	Service Factor	1
Phase	1	Duty	Continuous Air Over
Insulation Class	B	Frame	48
Enclosure	Totally Enclosed Air Over	Thermal Protection	Thermally Protected
Ambient Temperature	70 °C	UL	Recognized
CSA	Y	CE	N

Technical Specifications

Electrical Type	Permanent Split Capacitor	Poles	6
Rotation	Reversible	Mounting	Round Belly Band
Motor Orientation	Any	Drive End Bearing	Ball
Opp Drive End Bearing	Ball	Frame Material	Rolled Steel
Shaft Type	Double Flat	Overall Length	13.21 in
Frame Length	5.57 in	Shaft Diameter	0.500 in
Shaft Extension	6.50 in	Thru-bolts Extension	1 in

This is an uncontrolled document once printed or downloaded and is subject to change without notice. Date Created:25/10/2019

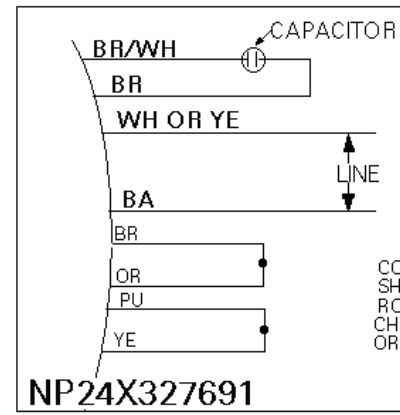

FILE:	DPC #
-------	-------